

Varenummer: 0102226
 Beskrivelse: Seeger låsering J 480 DIN 472
 Fjederstål

Mål

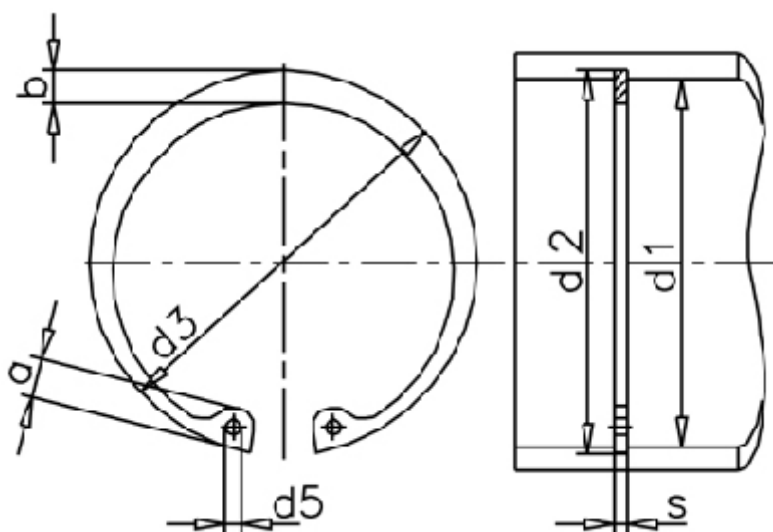

a max	= -	FN kN	= 1526.00	t	= 6.00
AN mm ²	= 9161.0	FRg kN	= 130.0	Tang	= ZGJ-5
b	= 26.0	FR kN	= 1306.0	tol	= -0.15
Betegnelse	= J 480	g	= 6.0	tol	= +2,00-1,00
d1	= 480	K kN-mm	= 2991.0	tol	= +1,00
d2	= 492.0	m min	= 7.20	vægt kg/1000	= 1640.00
d3	= 500.00	Nominel træk	= 18.0		
d5 min	= 6.0	s	= 7.00		